

The _____ Vacation

describing word

_____ and _____ are feeling very
name name

_____ about going on vacation. They have never
emotion

visited _____ before. They will pack a _____,
place thing

_____, and a _____ in a suitcase. Their family
thing thing

plans to travel in a _____. It will take about
type of transportation

_____ hours to get there. When the family arrives,
number

they will _____. Then they will _____ and
action action

_____. _____ and _____ will take
action name name

many photographs with their _____. They will send
object

_____ to their friends back home to describe the trip.
objects

Taking a vacation is very _____!
describing word

Puzzle Challenge

Level I

Complete the maze.

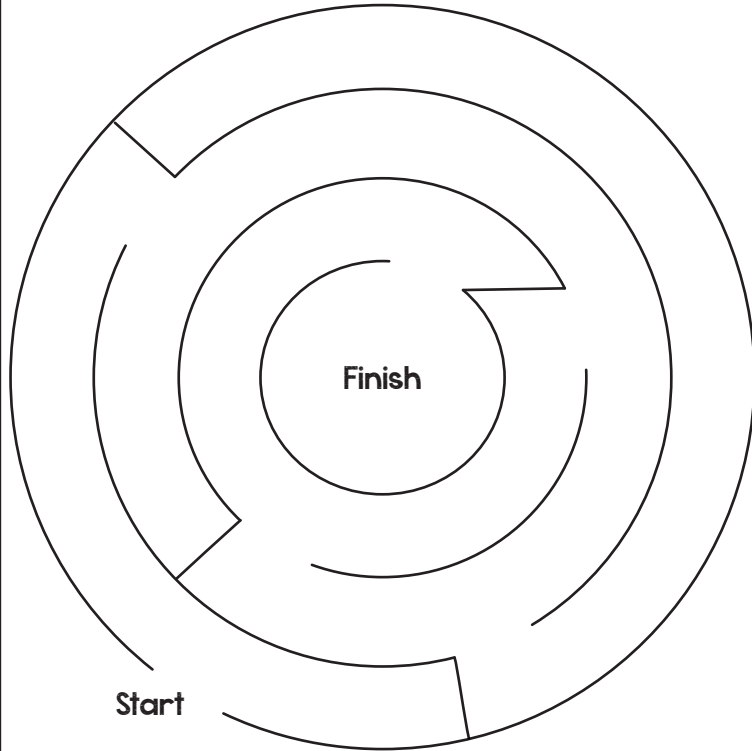

Connect the dots to finish the picture.

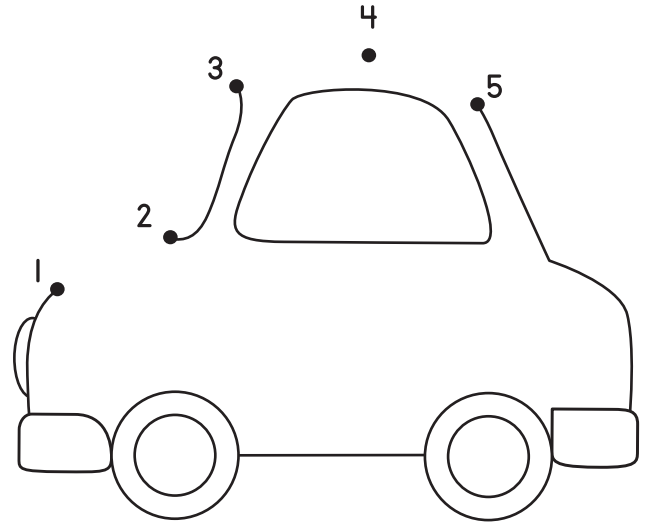

Circle the letter Ts.

Y T B W
E G T R
I P K T
T A Z C

Color the 1s blue and the 2s yellow.

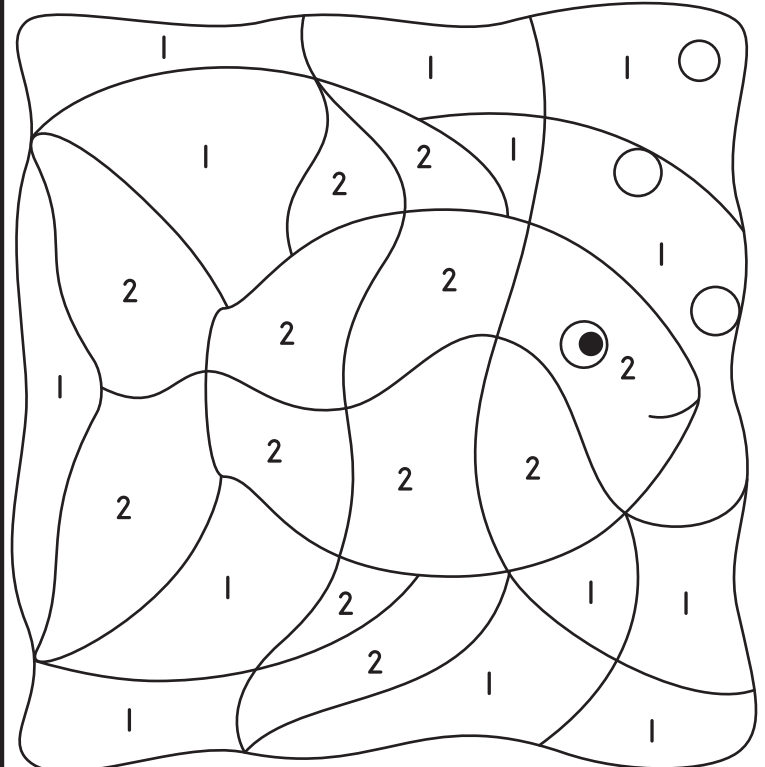

Puzzle Challenge

Level 2

Complete the maze.

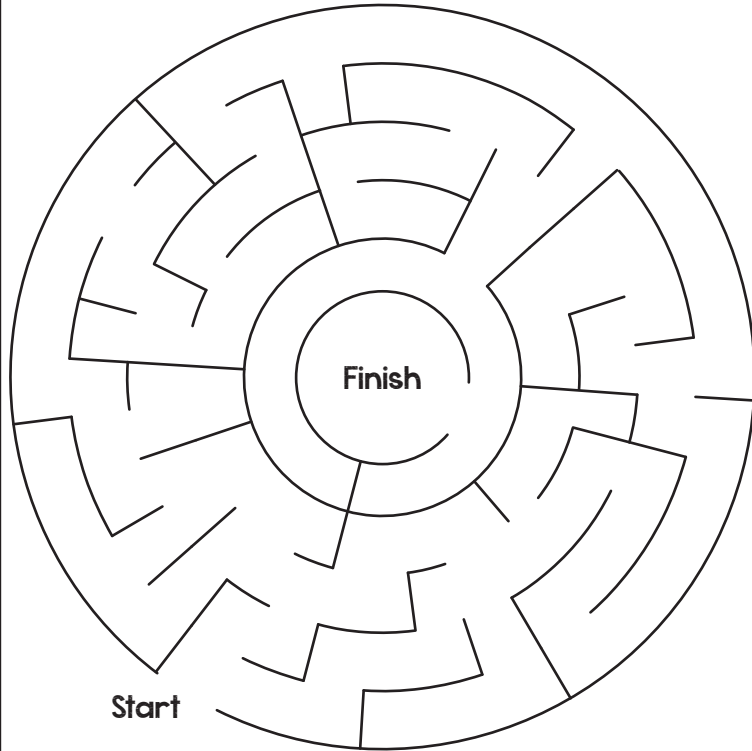

Connect the dots to finish the picture.

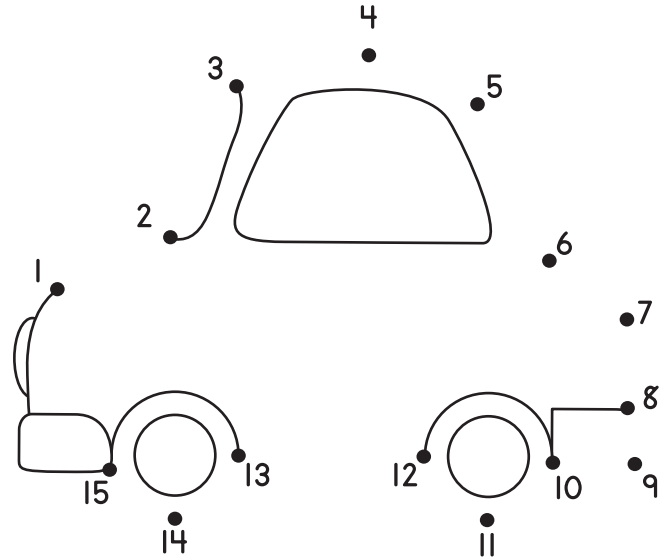

Circle the Ts. Place an X over the ts.

Y **T** **b** **W**
t **G** **T** **r**
i **t** **K** **T**
T **A** **t** **c**

Color the 1s blue, 2s yellow, 3s red, and 4s green.

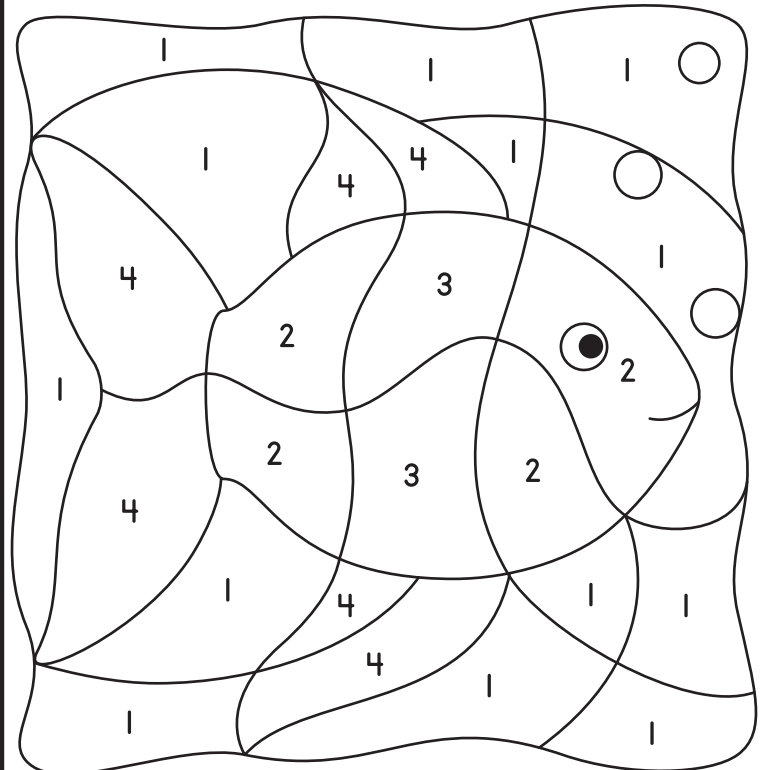



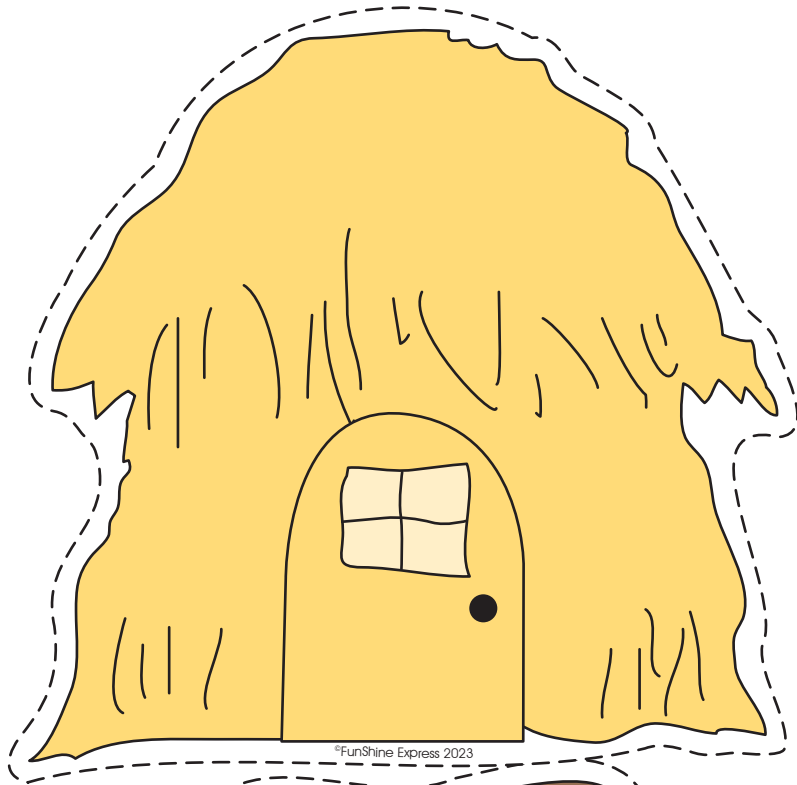

©FunShine Express 2023

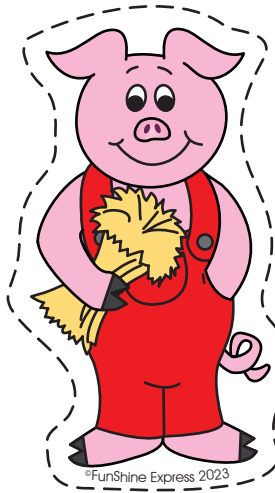

©FunShine Express 2023

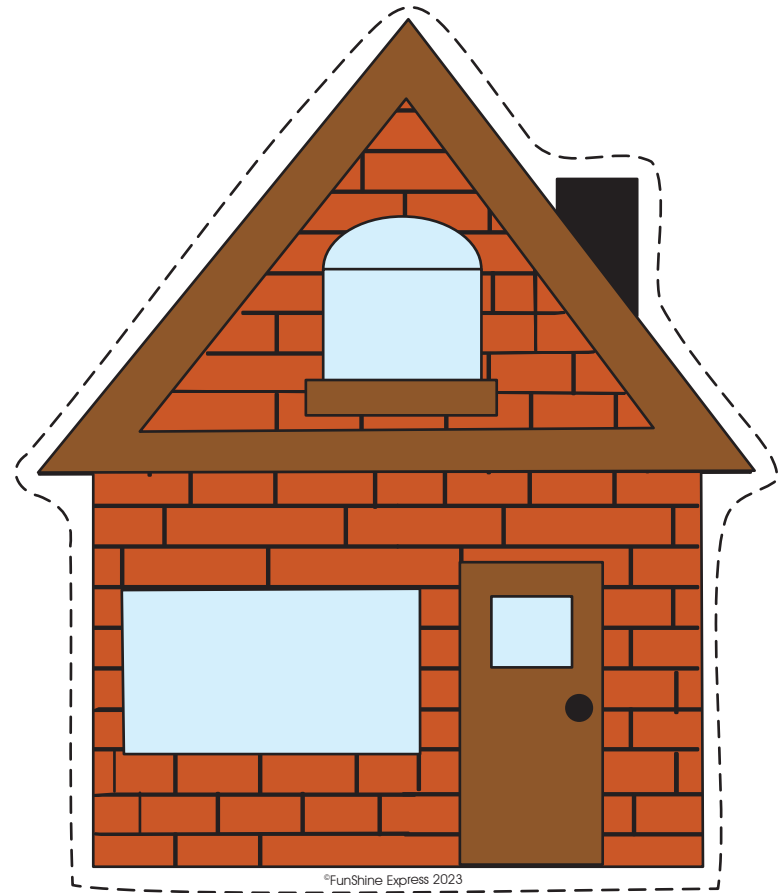

©FunShine Express 2023

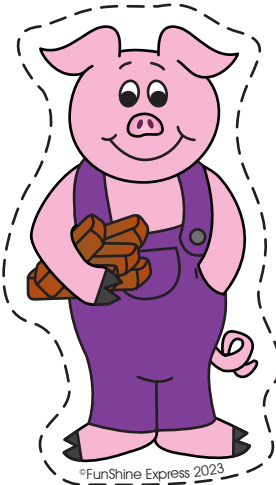

©FunShine Express 2023

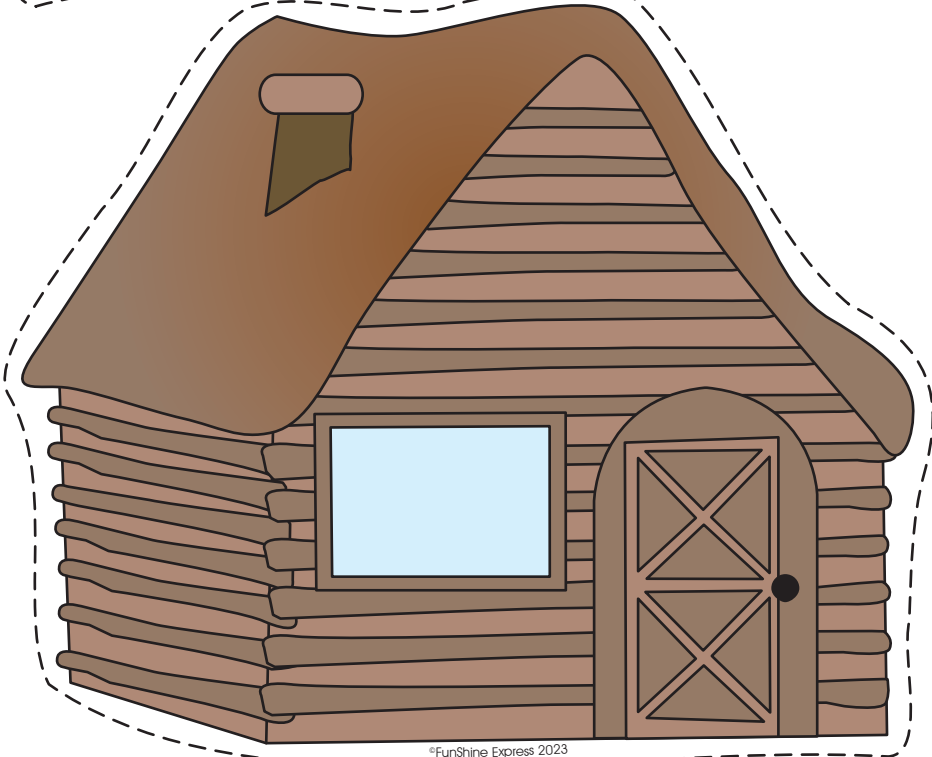

©FunShine Express 2023

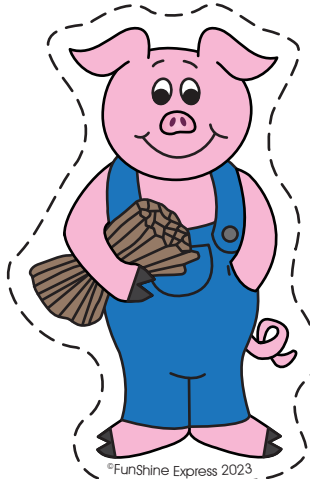

©FunShine Express 2023

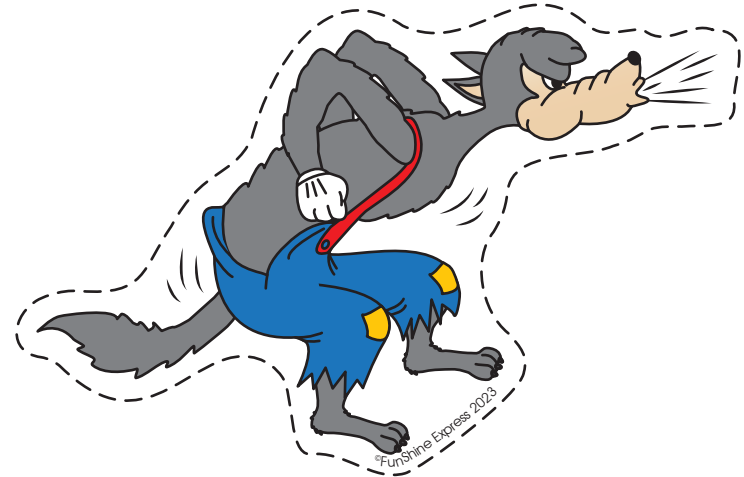

©FunShine Express 2023

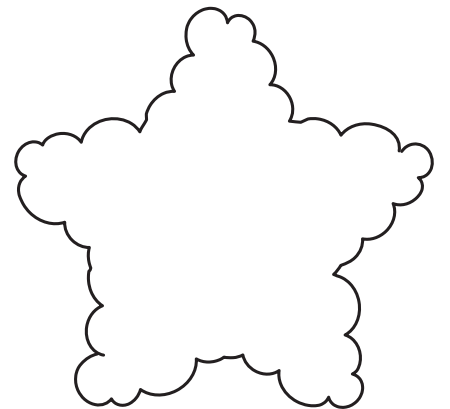
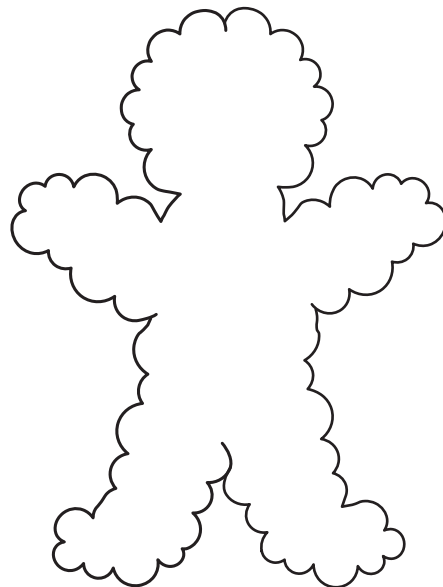
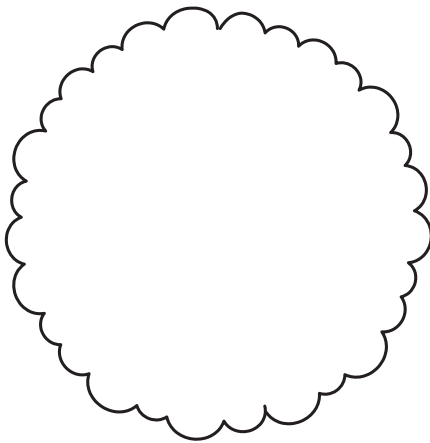
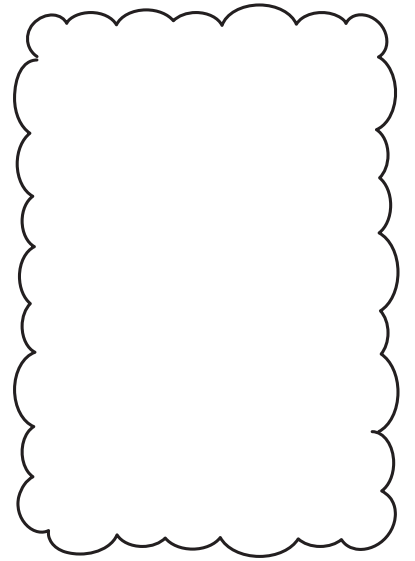
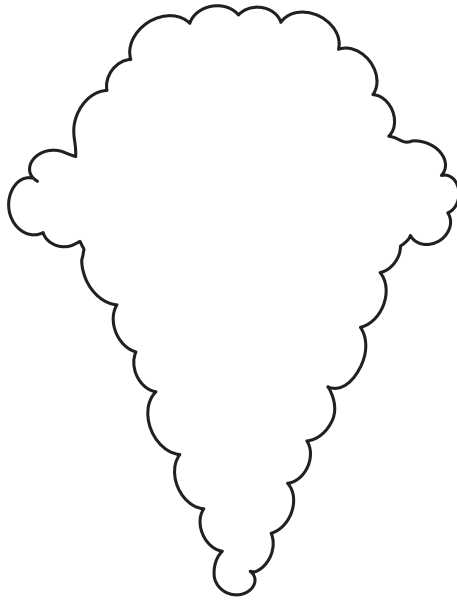
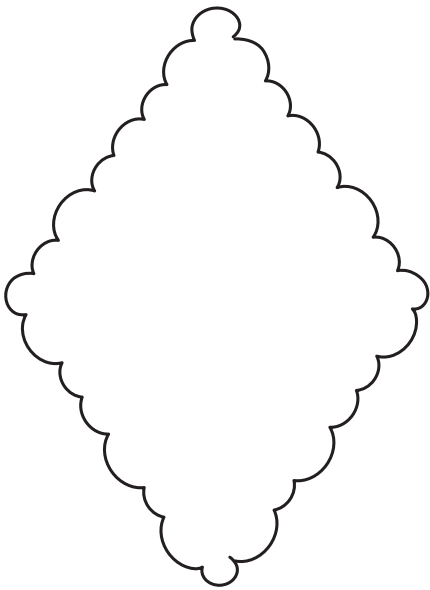
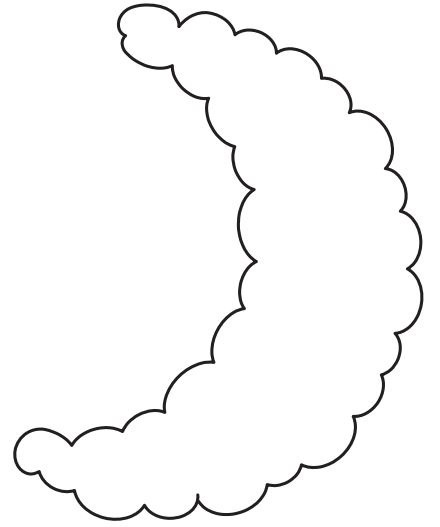
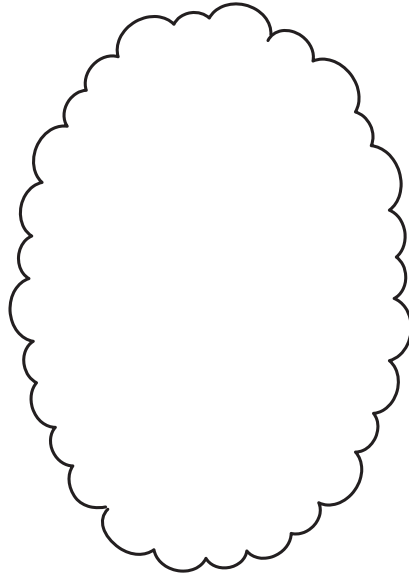
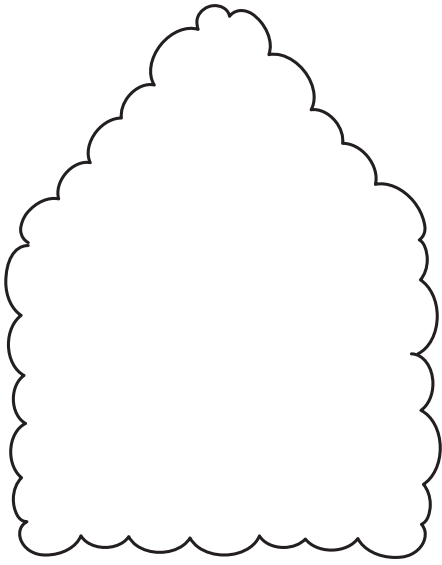

Spanish Size Terms

English	Spanish	Pronunciation
itty-bitty	<i>pequeñito</i>	(peh-keh-NYEE-toh)
miniscule	<i>minúsculo</i>	(mee-NOOS-koo-loh)
miniature	<i>miniatura</i>	(mee-nee-ah-TOO-rah)
teeny	<i>chiquito</i>	(chee-KEE-toh)
teeny-weeny	<i>chiquitito</i>	(chee-kee-TEE-toh)
small	<i>pequeño</i>	(peh-KEH-nyoh)
medium	<i>mediano</i>	(meh-dee-AH-noh)
large	<i>grande</i>	(GRAHN-deh)
extra large	<i>extra grande</i>	(ehks-TRAH GRAHN-deh)
huge	<i>grandote</i>	(grahn-DOH-teh)
enormous	<i>enorme</i>	(eh-NOHR-meh)
colossal	<i>monumental</i>	(moh-noo-mehn-TAHL)